



TURBOSWITCH™ ULTRA-FAST HIGH VOLTAGE DIODE

MAIN PRODUCT CHARACTERISTICS

I_{F(AV)}	1A
V_{RRM}	1200V
t_{rr} (typ)	65ns
V_F (max)	1.5V

FEATURES AND BENEFITS

- SPECIFIC TO THE FOLLOWING OPERATIONS: SNUBBING OR CLAMPING, DEMAGNETIZATION AND RECTIFICATION
- ULTRA-FAST AND SOFT RECOVERY
- VERY LOW OVERALL POWER LOSSES IN BOTH THE DIODE AND THE COMPANION TRANSISTOR
- HIGH FREQUENCY OPERATION
- HIGH REVERSE VOLTAGE CAPABILITY

DESCRIPTION

TURBOSWITCH 1200V drastically cuts losses in all high voltage operations which require extremely fast, soft and noise-free power diodes.

Due to their optimized switching performances they also highly decrease power losses in any associated switching IGBT or MOSFET in all freewheel mode operations.

ABSOLUTE RATINGS (limiting values)

Symbol	Parameter		Value	Unit
V _{RRM}	Repetitive peak reverse voltage		1200	V
I _{F(RMS)}	RMS forward current		6	A
I _{FRM}	Repetitive peak forward current	t _p = 5 μs F = 5kHz square	10	A
I _{FSM}	Surge non repetitive forward current	t _p = 10ms sinusoidal	20	A
T _{stg}	Storage temperature range		- 65 to + 150	°C
T _j	Maximum operating junction temperature		125	°C

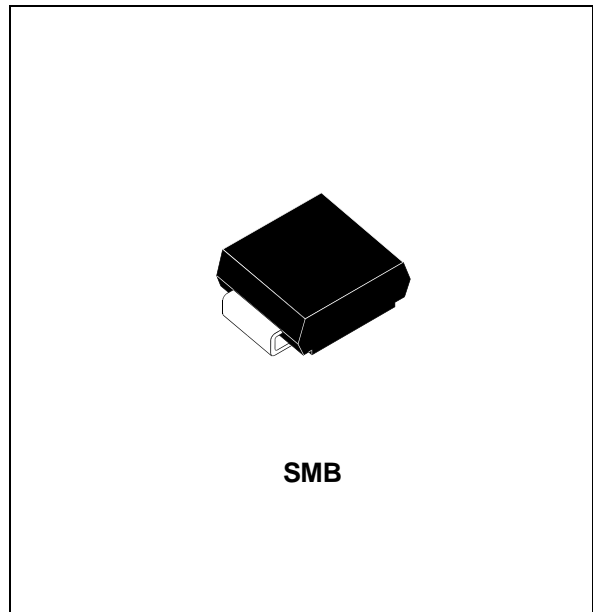

They are particularly suitable in motor control circuitries, or in primary of SMPS as snubber, clamping or demagnetizing diodes. They are also suitable for the secondary of SMPS as high voltage rectifier diodes.

STTA112U

THERMAL AND POWER DATA

Symbol	Parameter	Test conditions	Value	Unit
$R_{th(j-l)}$	Junction to lead thermal resistance		23	°C/W
P_1	Conduction power dissipation	$I_{F(AV)} = 0.8A$ $\delta = 0.5$ $T_{lead} = 93^\circ C$	1.4	W
P_{max}	Total power dissipation $P_{max} = P_1 + P_3$ ($P_3 = 10\% P_1$)	$T_{lead} = 90^\circ C$	1.5	W

STATIC ELECTRICAL CHARACTERISTICS

Symbol	Parameter	Test conditions		Min	Typ	Max	Unit
V_F *	Forward voltage drop	$I_F = 1A$	$T_j = 25^\circ C$ $T_j = 125^\circ C$		1.1	1.65 1.5	V
I_R **	Reverse leakage current	$V_R = 0.8 \times V_{RRM}$	$T_j = 25^\circ C$ $T_j = 125^\circ C$		90	10 300	μA
V_{to}	Threshold voltage	$I_p < 3 \cdot I_{F(AV)}$	$T_j = 125^\circ C$			1.15	V
R_d	Dynamic resistance					350	m Ω

Test pulses : * $t_p = 380 \mu s$, $\delta < 2\%$
 ** $t_p = 5 ms$, $\delta < 2\%$

To evaluate the maximum conduction losses use the following equation :

$$P = V_{to} \times I_{F(AV)} + R_d \times I_F^2(RMS)$$

DYNAMIC ELECTRICAL CHARACTERISTICS

TURN-OFF SWITCHING

Symbol	Parameter	Test conditions	Min	Typ	Max	Unit
t_{rr}	Reverse recovery time	$T_j = 25^\circ C$ $I_F = 0.5 A$ $I_R = 1A$ $I_{rr} = 0.25A$ $I_F = 1 A$ $di_F/dt = -50A/\mu s$ $V_R = 30V$		65	115	ns
I_{RM}	Maximum recovery current	$T_j = 125^\circ C$ $V_R = 600V$ $I_F = 1A$ $di_F/dt = -8 A/\mu s$ $di_F/dt = -50 A/\mu s$		5	1.8	A
S factor	Softness factor	$T_j = 125^\circ C$ $V_R = 600V$ $I_F = 1A$ $di_F/dt = -50 A/\mu s$		0.7		-

TURN-ON SWITCHING

Symbol	Parameter	Test conditions	Min	Typ	Max	Unit
t_{fr}	Forward recovery time	$T_j = 25^\circ C$ $I_F = 1 A$, $di_F/dt = 8 A/\mu s$ measured at $1.1 \times V_F \max$			900	ns
V_{Fp}	Peak forward voltage				35	V

Fig. 1: Conduction losses versus average current.

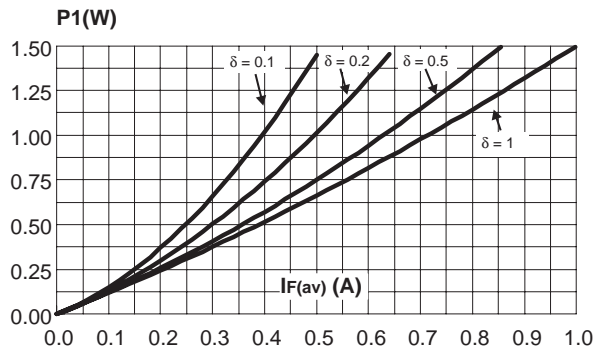

Fig. 2: Forward voltage drop versus forward current (Maximum values).

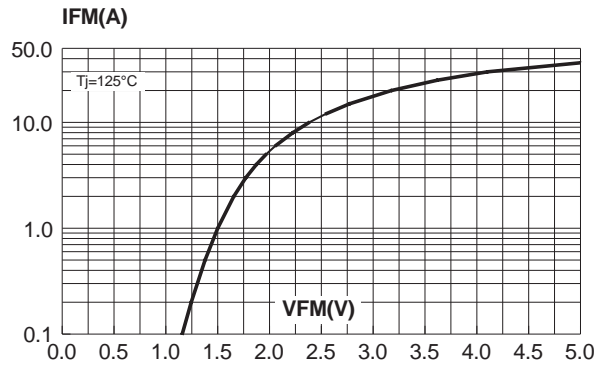

Fig. 3: Relative variation of thermal transient impedance junction to lead versus pulse duration.

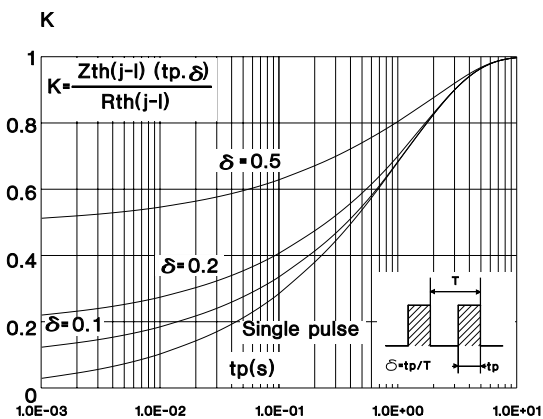

Fig. 4: Peak reverse recovery current versus di_F/dt (90% confidence).

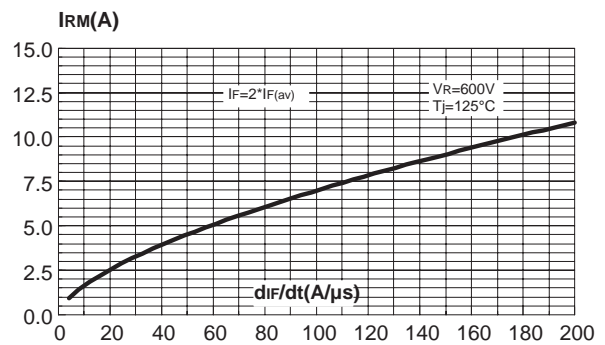

Fig. 5: Reverse recovery time versus di_F/dt (90% confidence).

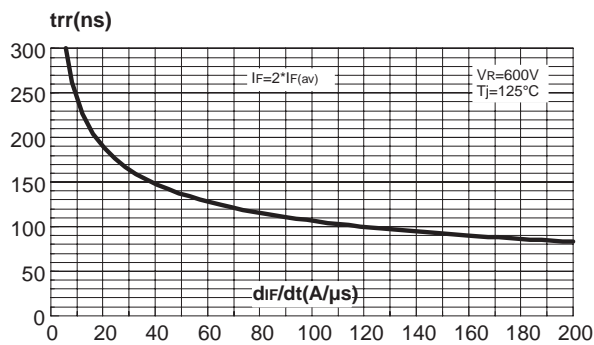

Fig. 6: Softness factor (tb/ta) versus di_F/dt (Typical values).

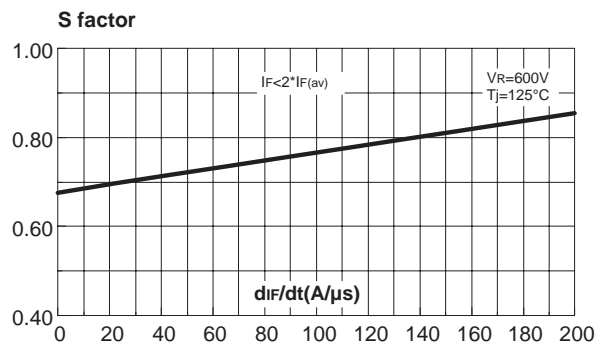

Fig. 7: Relative variation of dynamic parameters versus junction temperature (Reference $T_j=125^\circ\text{C}$).

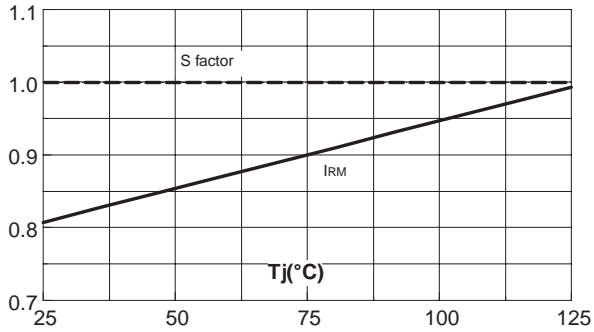

Fig. 8: Transient peak forward voltage versus di_F/dt (90% confidence).

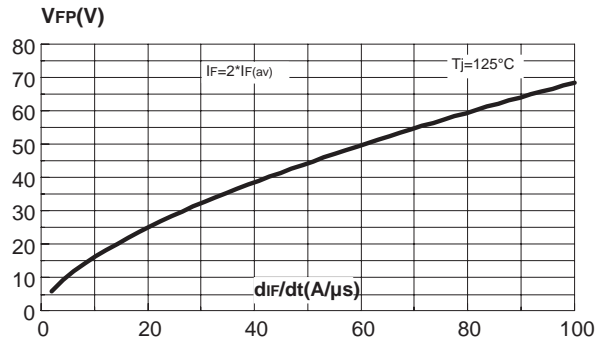
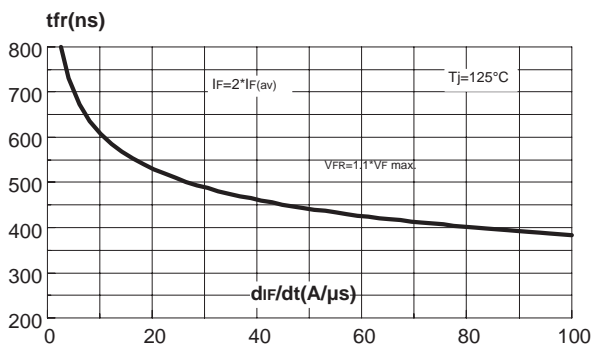

Fig. 9: Forward recovery time versus di_F/dt (90% confidence).



APPLICATION DATA

The 1200V TURBOSWITCH™ series has been designed to provide the lowest overall power losses in all frequency or high pulsed current operations.

In such application (fig. A to D), the way of calculating the power losses is given below :

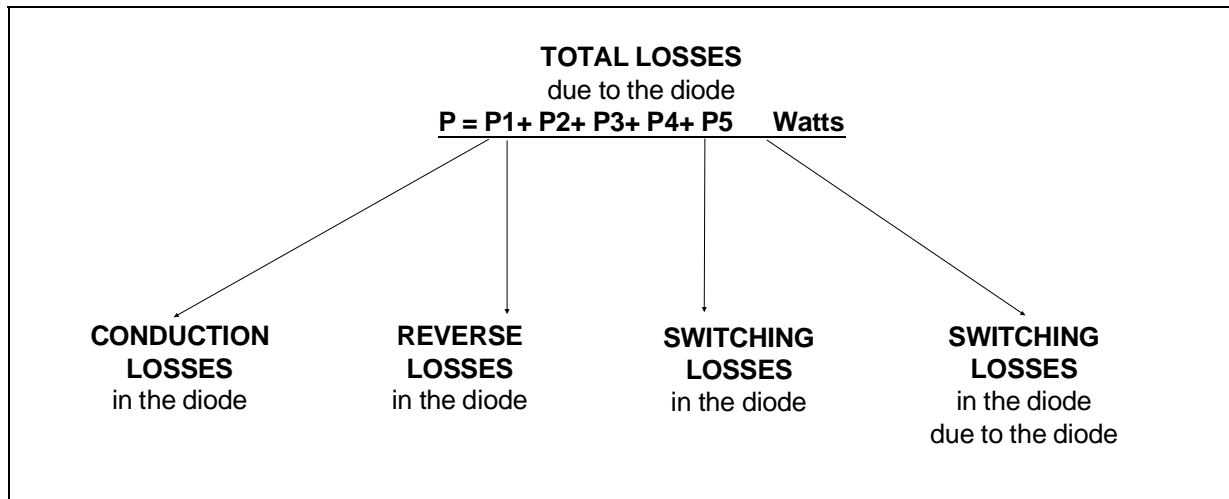
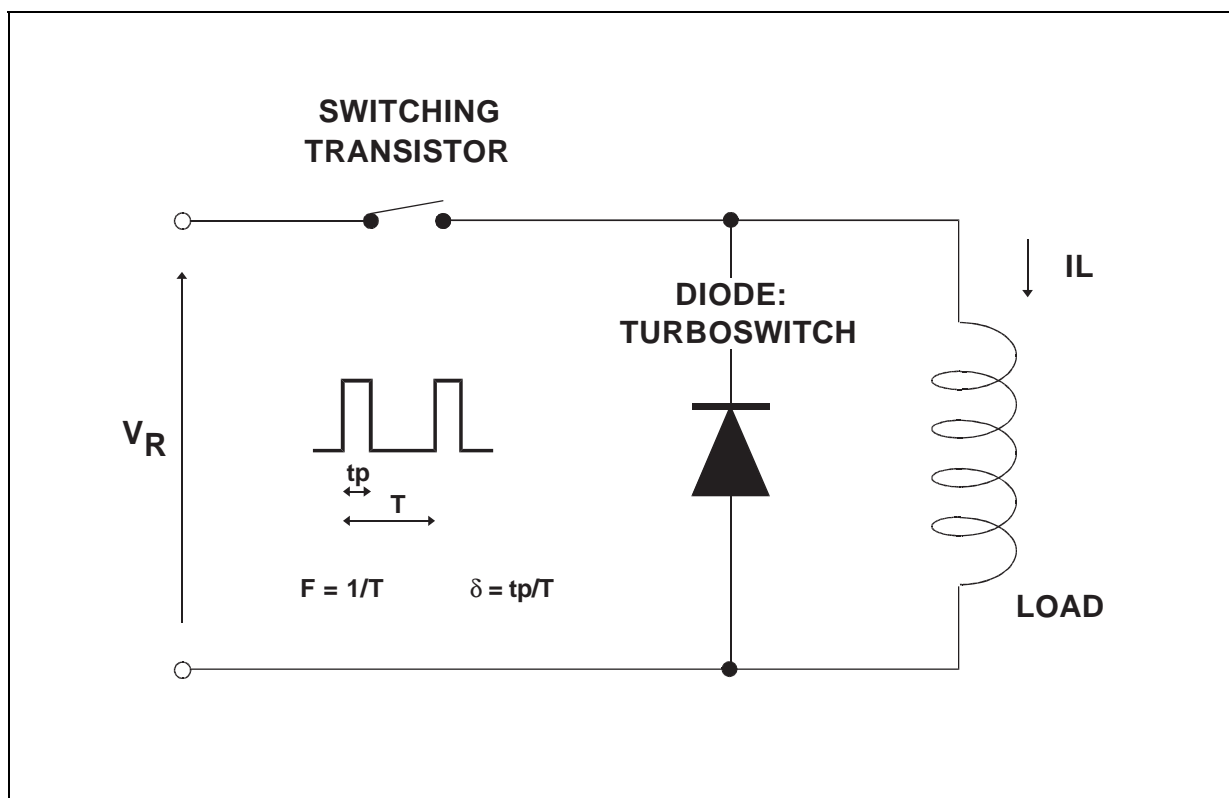

Fig. A : "FREEWHEEL MODE".



APPLICATION DATA (Cont'd)

Fig. B : SNUBBER DIODE.

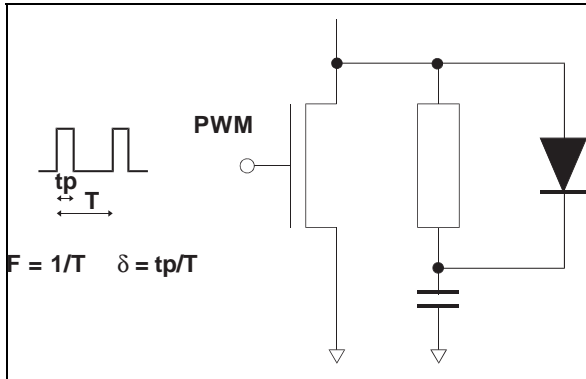

Fig. C : DEMAGNETIZING DIODE.

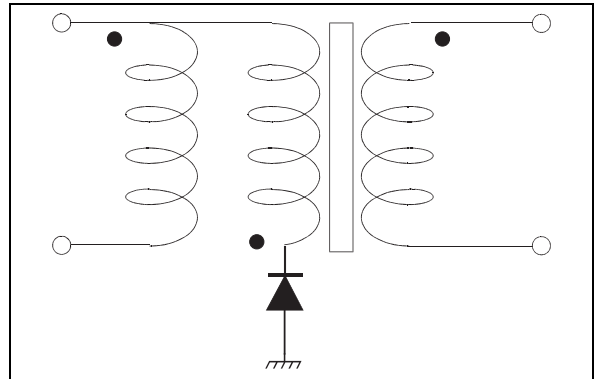

Fig. D : RECTIFIER DIODE.

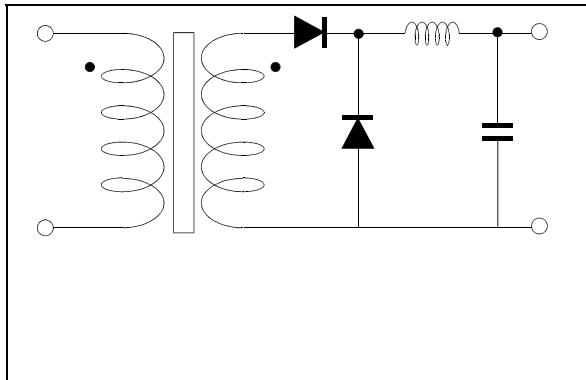
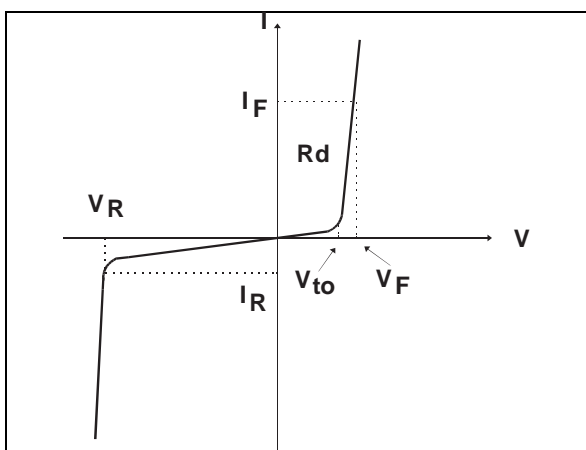

Fig. E : STATIC CHARACTERISTICS.



Conduction losses :

$$P1 = V_{to} \times I_F(AV) + R_d \times I_F^2(RMS)$$

Reverse losses :

$$P2 = V_R \times I_R \times (1 - \delta)$$

APPLICATION DATA (Cont'd)

Fig. F : TURN-OFF CHARACTERISTICS.

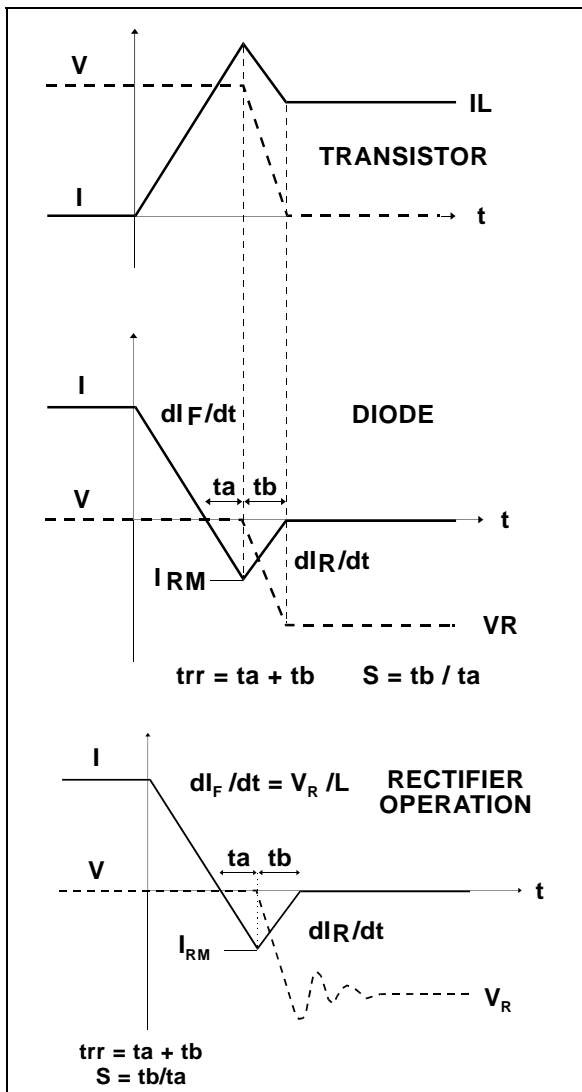
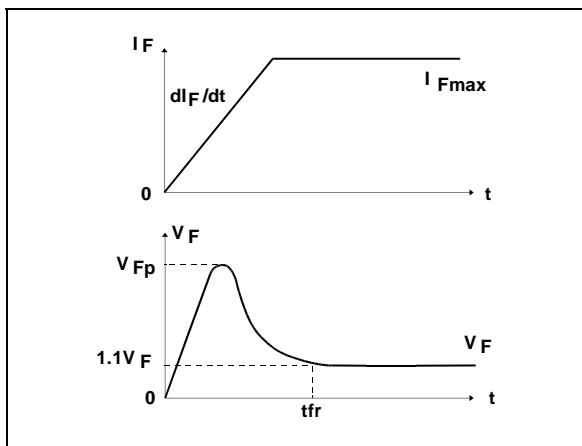

Fig. G : TURN-ON CHARACTERISTICS.



Turn-on losses :
(in the transistor, due to the diode)

$$P5 = \frac{V_R \times I_{RM}^2 \times (3+2 \times S) F}{6 \times dI_F/dt} + \frac{V_R \times I_{RM} \times I_L \times (S+2) \times F}{2 \times dI_F/dt}$$

Turn-off losses :

$$P3 = \frac{V_R \times I_{RM}^2 \times S \times F}{6 \times dI_F/dt}$$

Turn-off losses :
with non negligible serial inductance

$$P3' = \frac{V_R \times I_{RM}^2 \times S \times F \times L \times I_{RM}^2 \times F}{6 \times dI_F/dt + 2}$$

P3, P3' and P5 are suitable for power MOSFET and IGBT

Turn-on losses :
 $P4 = 0.4 (V_{FP} - V_F) \times I_{Fmax} \times t_{fr} \times F$

STTA112U

PACKAGE MECHANICAL DATA SMB

REF.	DIMENSIONS			
	Millimeters		Inches	
	Min.	Max.	Min.	Max.
A1	1.90	2.45	0.075	0.096
A2	0.05	0.20	0.002	0.008
b	1.95	2.20	0.077	0.087
c	0.15	0.41	0.006	0.016
E	5.10	5.60	0.201	0.220
E1	4.05	4.60	0.159	0.181
D	3.30	3.95	0.130	0.156
L	0.75	1.60	0.030	0.063

FOOTPRINT DIMENSIONS (in millimeters)

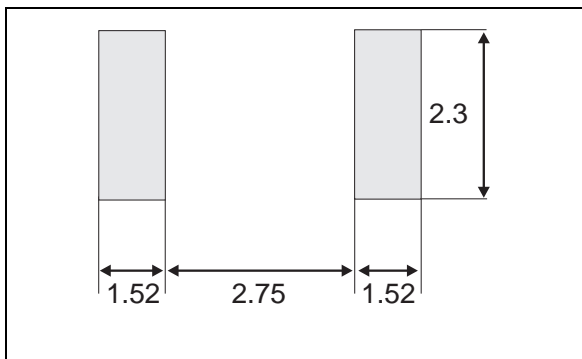

Ordering type	Marking	Package	Weight	Base qty	Delivery mode
STTA112U	T03	SMB	0.107g	2500	Tape & reel

- Epoxy meets UL94,V0
- Band indicates cathode

Information furnished is believed to be accurate and reliable. However, STMicroelectronics assumes no responsibility for the consequences of use of such information nor for any infringement of patents or other rights of third parties which may result from its use. No license is granted by implication or otherwise under any patent or patent rights of STMicroelectronics. Specifications mentioned in this publication are subject to change without notice. This publication supersedes and replaces all information previously supplied. STMicroelectronics products are not authorized for use as critical components in life support devices or systems without express written approval of STMicroelectronics.

The ST logo is a registered trademark of STMicroelectronics

© 1999 STMicroelectronics - Printed in Italy - All rights reserved.

STMicroelectronics GROUP OF COMPANIES

Australia - Brazil - China - Finland - France - Germany - Hong Kong - India - Italy - Japan - Malaysia
Malta - Morocco - Singapore - Spain - Sweden - Switzerland - United Kingdom - U.S.A.

<http://www.st.com>